

M LINE



boqballe 

FIND MORE INFORMATION AT
www.bogballe.com



THE COMPANY BEHIND THE WORLD'S BEST AND BIGGEST MINERAL FERTILISER SPREADER.

We are one of the world wide leading manufacturers of mineral fertiliser spreaders. 365 days a year we are thinking, developing and manufacturing the best techniques for distributing mineral fertiliser - a passion through generations.

Back in 1934 in the village of Bogballe, our founder Anders Peter Laursen started up manufacturing of equipment for chicken production. Times changed and in the beginning of the 1950's focus was brought onto our well known blue fertiliser spreaders. Today the third generation are managing BOGBALLE A/S, continuing a proud tradition.

Optimal functionality and user-friendly design are based on years of practical experience in co-operation with farmers world wide.

At our disposal we have the latest high technology production facilities combined with proven facilities for development and full scale testing in our test hall. We are working all year around analysing fertiliser specifications, testing and formulating spread charts by spreading more than 200 ton of fertiliser each year. Our test hall is one of Europe's biggest and most advanced and the only facility that is set up with two systems to manage both 2D and 3D testing.



International tests	5
Hard-hitting arguments	7
EASY Setting	9
The best weighing technique	11
More than a fertiliser spreader	13
The best spreading system	15
Traffic and safety	23
Transmission and drive systems	27
Surface treatment	29
Test and development	31
Connectivity	33
Intelligent speed	39
Wedge spreading	41
Application map	43
We will carry the load	45
Equipment and accessories	47
Models	49

BOGBALLE A/S make certain reservations to typing errors, technical errors or typographical errors. All BOGBALLE products are subject to continuous development. Information in this leaflet can therefore be changed without notice.



AGROSS Klíčany, Ondrej Bačina (CZ)

Top application, performance and capacity. Our next fertiliser spreader will without doubt be a blue and yellow spreader. We are also sure that this spreader must have the weighing technique as the advantages are clear particularly for handling variations in fertiliser.



Finn Nielsen (DK)

We have been using the spreader throughout the whole season for both fertilising, slug pellets and for aftercrop. The multipurpose use means that it is not just a fertiliser spreader. That makes the BOGBALLE spreader a cost effective investment, reducing the cost of additional machine investments.



CONTINUOUS SUCCESS

We are the specialists in spreading techniques and precision. It requires courage and self-confidence to claim so, but focusing 365 days a year on only one niche product - makes us a specialist within our discipline.

100% focus on functionality, precision and design gives us the skills to develop what we call "the worlds best fertiliser spreader".

Over many years we have participated in many international test events - always with a terrific performance. Again and again the test results show that we offer ultimate precision when it comes to our core competence - the distribution of mineral fertiliser.

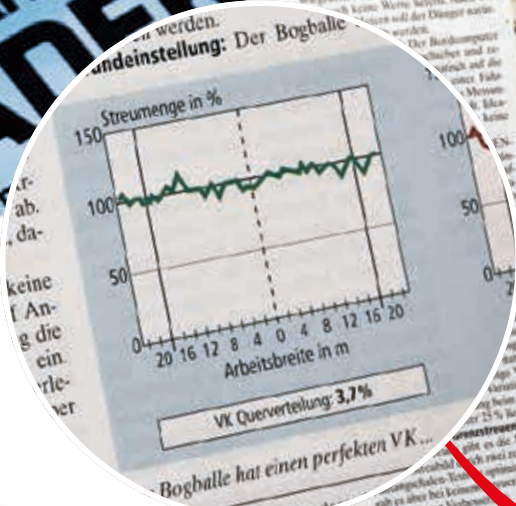

International test carried out by Top Agrar
Coefficient of variation: 3,7%

SEE ALL MODELS AT
www.bogballe.com



HOLD STRONG CARDS - WITHOUT GAMBLING.

The new M-Line is ready and more Dynamic than ever. A range of up-to-date, innovative features puts you in a position to meet the tasks of today and for the future.

The design of the spreader and the versatility of the quantity control makes the machine more than just a fertiliser spreader - and with the impressive spreading technique you hold the strongest card.

In other words : An investment in an M-line spreader offers reliability during field work, handling high value fertilisers with care and applied with maximum precision - exactly as you would wish !

HARD-HITTING ARGUMENTS

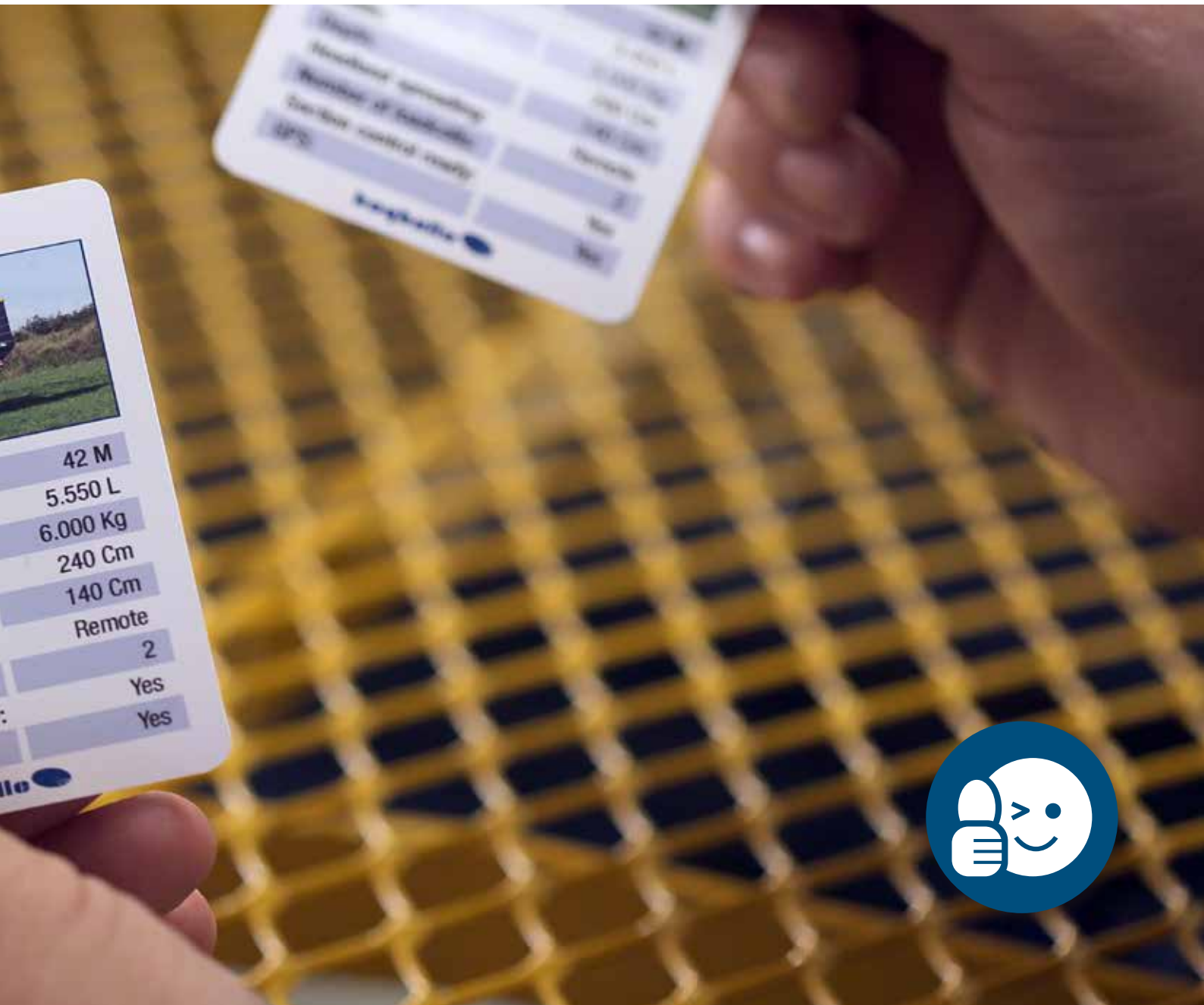

	M60W plus	M45W plus	M35W plus	M35W base	M45 plus	M35 plus	M35 base
Working width							
12-42							
Capacity							
Litres	4.050-5.550	1.800-4.500	1.800-3.500	1.250-3.000	1.800-4.500	1.800-3.500	1.250-3.000
Kilo	4.450-6.000	1.980-4.500	1.980-3.500	1.370-3.000	1.980-4.500	1.980-3.500	1.370-3.000
Control unit							
CALIBRATOR ZURF	●	●	●	●	○	○	○
CALIBRATOR ICON	—	—	—	—	○	○	○
ISOBUS Controller	●	●	●	●	—	—	—
iZURF WIFI module*	○	○	○	○	○	○	○
Hydraulic	—	—	—	—	○	○	○

- Standard
- Depending on model
- Extra
- Not available

* With CALIBRATOR ZURF only

3 QUICK WAYS FOR SIMPLE AND EFFECTIVE SETTING.

Weighing technique

If you choose a spreader with weighing technique, adjustment of the spreader is fully automatic. The flow of the fertiliser is controlled by the weighing system and the opening of the outlets is adjusted according to the required application rate and the actual forward speed.

Speed independent quantity control

If you choose a spreader with quantity control independent of forward speed, then simply key in the flow factor defined in our spread charts. Alternatively, use the S-indicator to define the flow rate for a specific fertiliser.

Remote or manual control

If you choose a spreader with hydraulic or manual control, use the settings in our spread charts or use the S-indicator to determine the settings for a specific fertiliser.



EASY SETTING

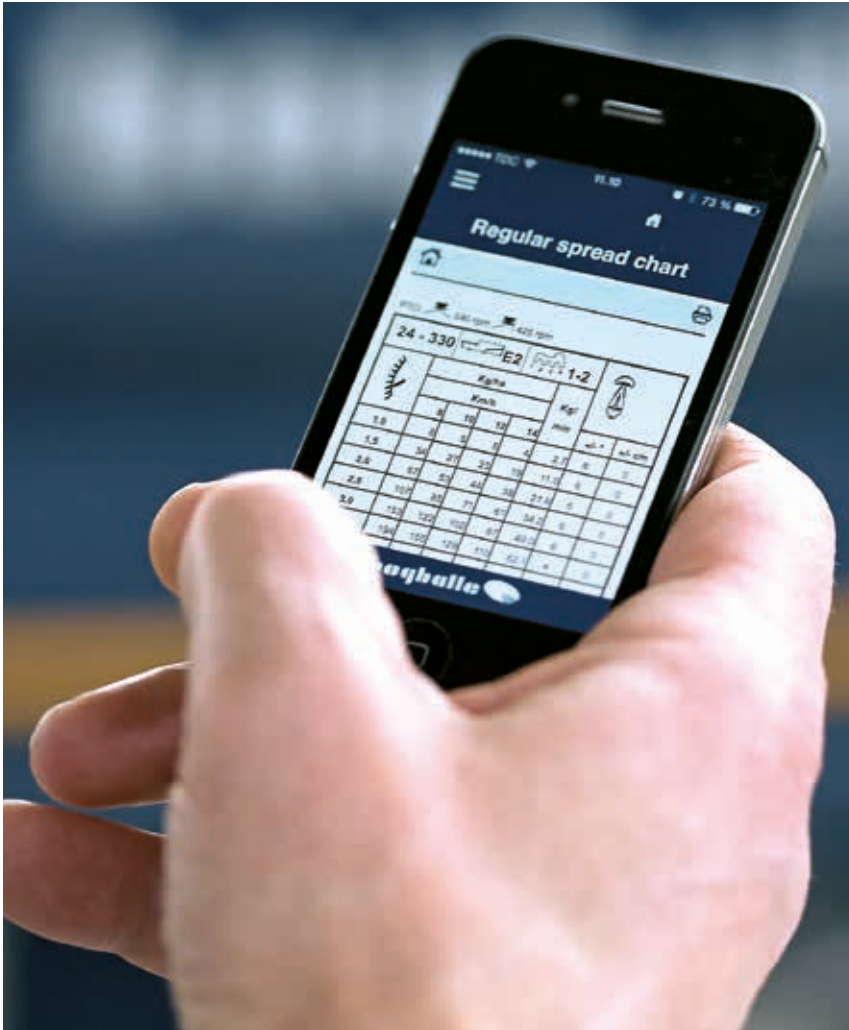

Latest, up to date spread charts are available via App or web.



The S-indicator is easy to use and a complete flow test of a specific fertiliser is carried out in a few minutes.



Spreaders fitted with weighing technique are automatically calibrated on the move, so there is no need for a manual flow test.



Detection of irregularities by weighing system



Detection of irregularities by Intelligent Control



WHO WEIGHS - IS IN TOTAL CONTROL MORE THAN 30 YEARS OF DEVELOPMENT.

As a pioneer of the weighing technique, Bogballe has over the last 30 years continued to develop and refine the weighing system to perfection. It is now a system that defines the highest standards for precise distribution.

The technique is based on the 1:1 principle, in which the weight of the actual hopper contents is continuously monitored. The flow rate leaving the hopper is fine tuned to achieve the target quantity (kg/ha). This direct input gives 100% control of both application quantity and contents during field work.

We use a robust 6 ton weigh cell linked to an absolutely parallel double frame which results in only the actual hopper contents being measured. An uncompromising weighing technique for total precision.

The system is continually monitoring the actual flow rate and keeps the operator informed via the CALIBRATOR or the ISOBUS Terminal.

THE BEST WEIGHING TECHNIQUE

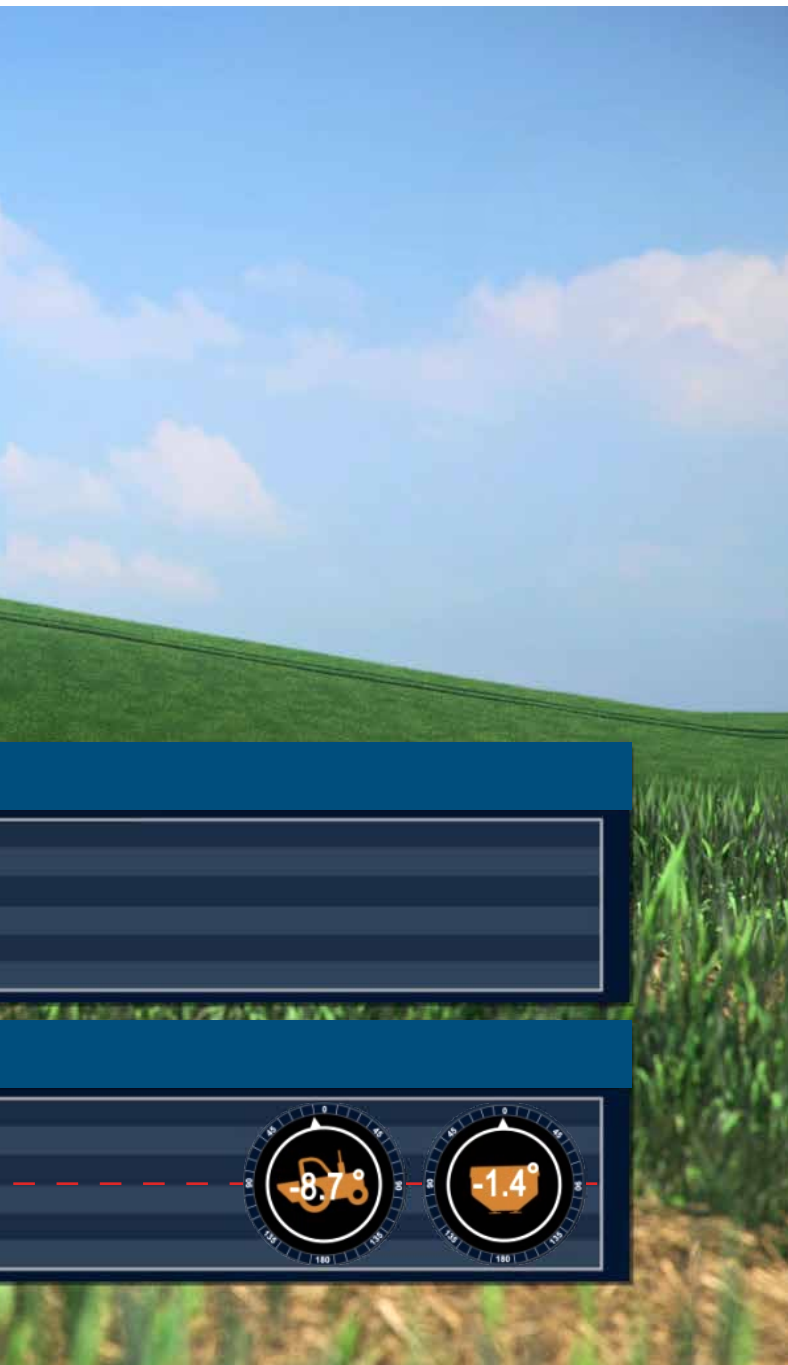

INTELLIGENT CONTROL - DOUBLE CHECK ACCURACY

To give exact weighing under all conditions, the spreader is equipped with an Intelligent Control (IC) feature, that combines two important elements: An Accelerometer and an Inclinometer.

The Accelerometer records and separates the bumps and shocks from driving on uneven ground, so only the actual and real hopper contents are registered.

The Inclinometer records the position of the spreader compared to horizontal for precise control, even when working on up, down or across slopes.

The diagram shows the actual weigh cell reading during spreading under field conditions. The red IC line shows how the Intelligent Control is able to monitor the weight signal and discard incorrect values to give a true weight reading.

Intelligent Control is a reliable necessity to carry out totally precise automatic calibration, continuously on-the-move to accurately control the application quantity.

100% Control

PRECISE QUANTITY AND EFFICIENT CONTROL FROM 0 - 650 KG/MIN.

The M-line is a high capacity spreader, equipped with a rotating flow-outlet for precise setting of rates from 0 - 650 Kg/min. It is possible to choose between four different outlet positions for maximum accuracy from very low to very high quantities.

This possibility increases the versatility of the spreader adding more uses from spreading fertiliser, to seeds and slug pellets.

At full opening, the spreader has a huge output capacity of up to 650 Kg/min . . . equivalent to applying 600kg/ha at 36m at forward speed of 18kph!

Integration between the four flow outlets and our electronic controllers offers easy and logical setting.



0 - 650 Kg/min.

MORE THAN A FERTILISER SPREADER



[OFF]
[OFF]

A close-up of the fertilizer spreader dial set to the OFF position. The dial is blue with a white indicator line pointing to the OFF mark.

[MAX]
Maximum
Up to 650 Kg/min.

A close-up of the fertilizer spreader dial set to the MAX position. The dial is blue with a white indicator line pointing to the MAX mark.

[STD]
Standard.
Up to 300 Kg/min.

A close-up of the fertilizer spreader dial set to the STD position. The dial is blue with a white indicator line pointing to the STD mark.

[MIN]
Minimum.
Up to 75 Kg/min.

A close-up of the fertilizer spreader dial set to the MIN position. The dial is blue with a white indicator line pointing to the MIN mark.

[MIC]
Micro.
0,5-15 kg/min.
>2,5 kg/ha

A close-up of the fertilizer spreader dial set to the MIC position. The dial is blue with a white indicator line pointing to the MIC mark.

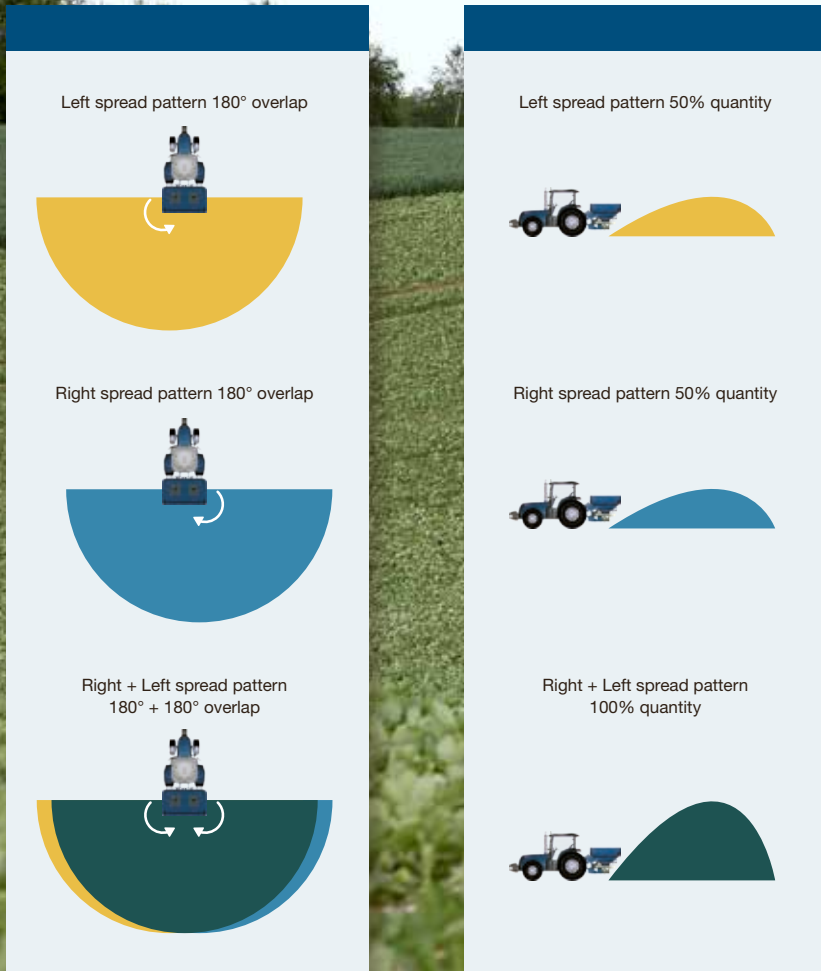

Test trays

If in any doubt about the physical quality of the fertiliser, it is always good practice to make sure that the spreader is adjusted correctly by using test trays.



Measuring cylinders

The perfect spread pattern with correct overlapping is achieved when the contents of the seven measuring cylinders are all in line.

THE BEST SPREADING SYSTEM



IN-CENTRE SPREADING. OPTIMAL FOR NORMAL SPREADING.

Our In-centre spreading system with the discs spinning towards each other, is recognized as a high precision system with a minimum of settings. In practice this means maximum certainty to obtain an even distribution.

The full 180 deg. overlap between the two discs, means that the right and the left side of the spreader does not need any individual adjustment to achieve the correct overlapping spread. Both discs individually cover the full area, so no need for extra settings.

24 metre working width

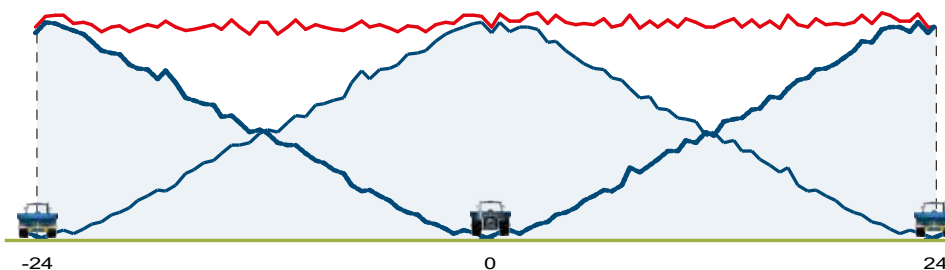

36 metre working width

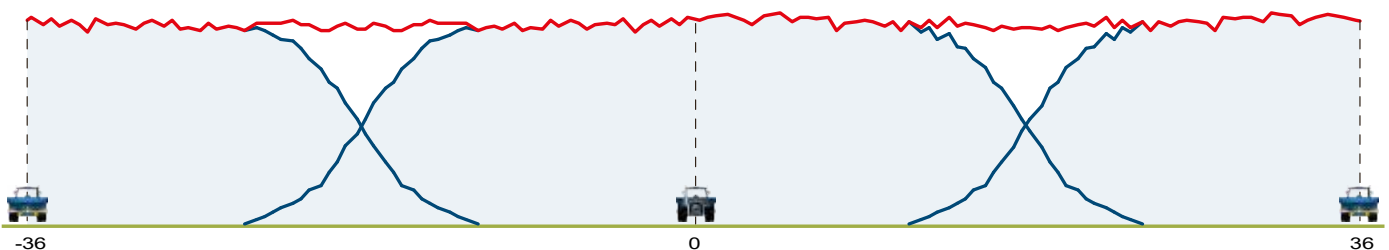

ONLY TO THE BORDER - THANKS!

Our headland spreading is based on the Off-centre spreading system. The rotation direction of the spreading discs is away from each other creating two individual spread patterns . . one a pattern towards the headland falling steeply at the border with a sharp cut-off and the other a full width pattern into the field area.

The back side of the spreading vanes are used for headland spreading and designed to produce half the spread width to the right side of the spreader.

Forward directed spread pattern when headland spreading.

The forward directed spread pattern on the headland side, makes sure that all the field is correctly fertilised, including in the corners. The amount of fertiliser at the headland border can be freely adjusted by changing the Pto revs to meet individual requirements.

Headland principles

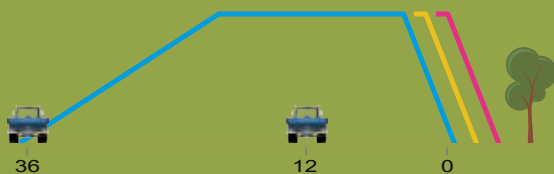

Different headland strategies

The PTO revs determines the headland pattern. Either minimum, medium or maximum quantity to the border.



Headland spreading from border

Additionally we offer a from border system, with the possibility to distribute the fertiliser via one disc only - spreading from the border into the field. This system results in a steep falling spread pattern at the border from 100% to no fertiliser within 1,5 metres.

THE OPTIMAL SPREADING SYSTEM

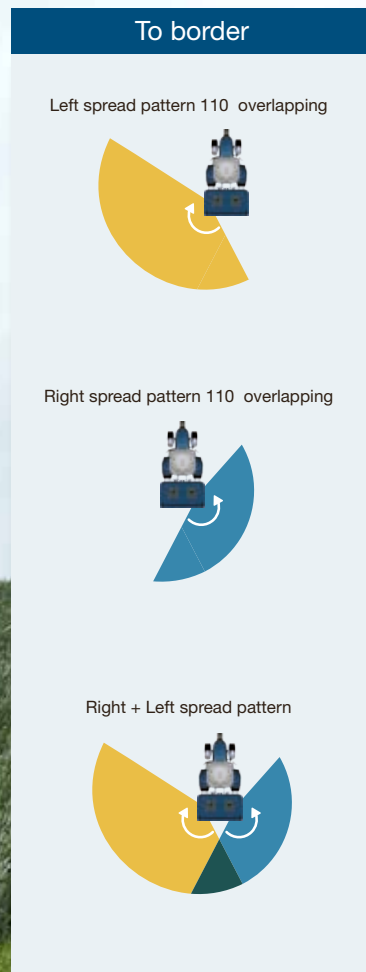
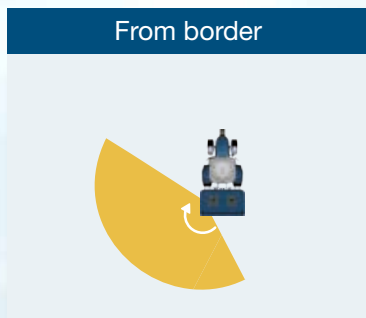
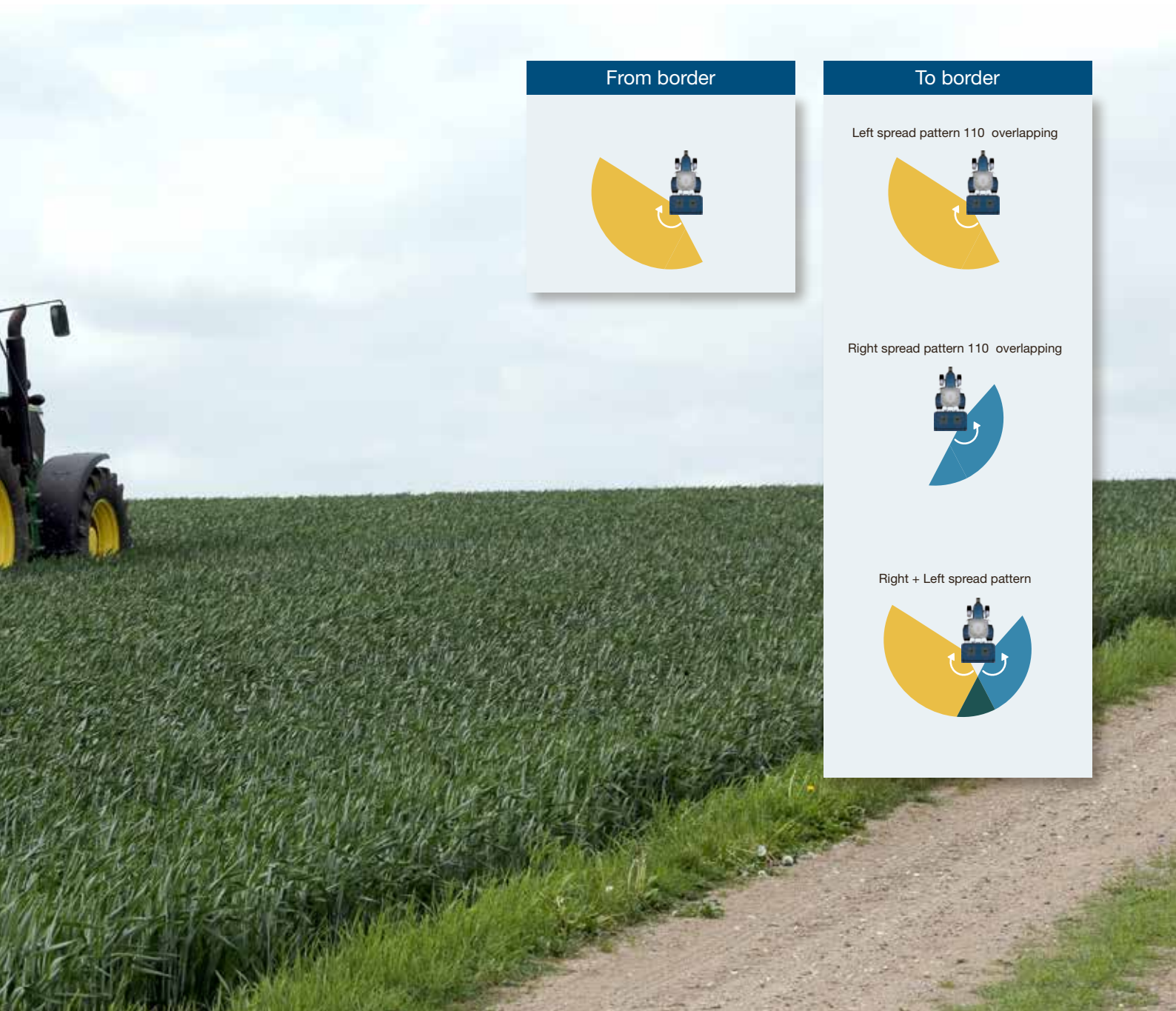

Headland spreading from border

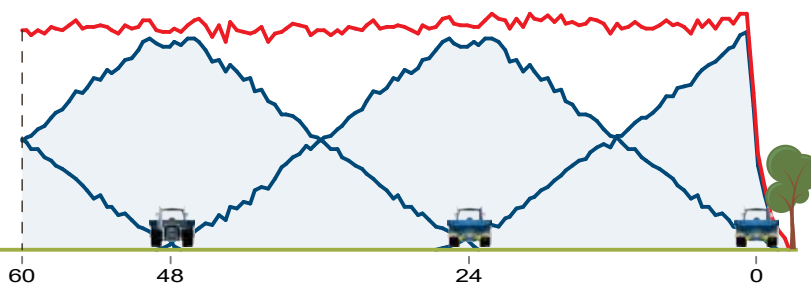

Headland spreading to border

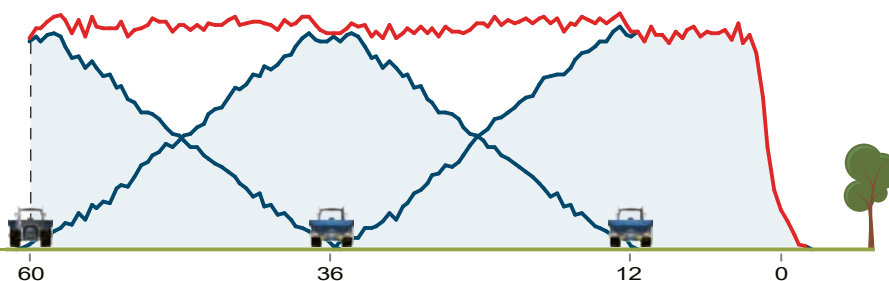

Integrated know how from the factory.

The BOGBALLE spreading technique is designed with focus on the minimal need for settings and adjustment. Our know how and expertise is an integrated part of the spreader, so not to leave complicated settings for the operator.

No manual adjustment

The outlet is designed to correct the drop point automatically and independent of the quantity spread - with no manual setting - and always achieving an even spread pattern.

Even during Variable Rate Application, or when activating the Dynamic Differential spreading system, or when changing the quantity according to crop conditions, or simply changing forward speed - the outlet system automatically compensates to maintain an accurate, even spread.

Constant flow

Our free wheeling agitators ensure a constant flow and particularly gentle handling of the fertiliser. The unique design delivers a constant flow without deviation and blockage.

The non powered, eccentric agitators automatically adjust the rotation speed according to the condition or type of fertiliser. The rotation speed varies between 10 revs. when spreading light fertiliser with a high flow rate and up to 60 revs. per minute

spreading a coarse fertiliser.

The cone protecting the agitator prevents against overloading and creates a constant flow from full hopper to empty.

Large spreading discs

The large and flat spreading discs distribute the fertiliser evenly across the complete area. Together with the unique asymmetric double outlet, the discs keep the spread pattern covering a 180 degree area no matter the quantity, working width or type of fertiliser.

Minimal drop distance

The low drop distance from the outlets to the spreading disc ensures that the spread pattern is not influenced by sloping or tilted ground. No adjustment or corrections.

Turn at the right place

Besides 100% overlapping and easy setting, the In-centre system has a crucial advantage. The system distributes the fertiliser from close to the spreader all the way across the spread pattern. Turning at the headland can therefore be completed in the headland tramline and not in the crop between the headland and the border. Significant crop damage is avoided by not having to turn in the crop.



Use the same tramlines and headland wheelings as the sprayer. The In-centre spread pattern is close to the spreader and does not require turning outside the headland tramlines.

THE BEST SPREADING SYSTEM



Working width: 28 m at 250 Kg/ha

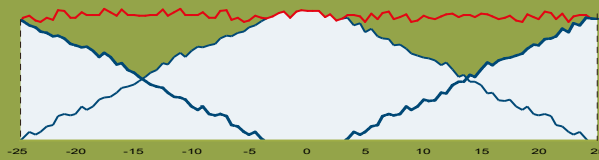

Working width: 28 m at 450 Kg/ha

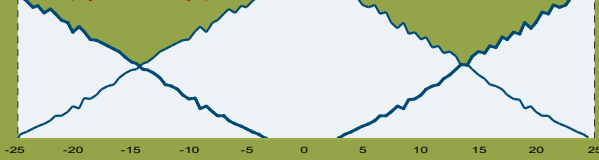

The large and flat spreading discs releases the fertiliser evenly on a 180 degree area.

The asymmetric opening of the unique double quantity shutters keeps the drop point in the correct position independent of the application quantity and forward speed.



The free wheeling agitator keeps a constant flow of fertiliser by a gentle and eccentric rotation.

SPREADER TECHNIQUE - WHERE THE DETAIL COUNTS.

Turbine effect

Our spreading technique utilises the turbine effect produced from the rotation of the spreading vanes. An air stream is guided through the guard vents creating a controlled vacuum which disperses the fertiliser evenly on the spreading disc, to optimise the spread result.

Stainless steel

The extensive use of stainless steel prevents corrosion and also protects the painted surfaces against damage from the fertiliser.

Easy access for adjustment

The spreader is equipped with two spirit levels to check the angle of the tractor and the spreader.

The top link is fitted with factory set and fixed horizontal spirit level - parallel with the spreading discs. This offers the opportunity for a double check that the adjustable spirit level is correctly calibrated.

THE BEST SPREADING SYSTEM



The rotation of the spreading discs draw a controlled airstream through the vents of the guard and releases the fertiliser evenly on the spreading disc.



The spirit level on the top link is fixed parallel with the spreading discs and is the reference point for the correct calibration of the working angle of the spreader.



Reflective panel

The fluorescent surface of the reflector is highly efficient and even in broad daylight will reflect with a visibility higher than traditional reflector panels. The BOGBALLE reflector fulfils the DIN 67520 standard .



Glow LED - special developed by BOGBALLE

100% water and dust proved. The 55 individual LED units provide extremely high visibility under all conditions. The Glow LED lights are approved according to EMC 10.5 E6 and classified as IP69-K.



SAFETY - BOTH DURING FIELD WORK AND ON THE ROAD.

Safety is important both during field work and in transport on public roads. The integrated safety solutions have been carefully considered in detail for design and functionality.

Highest visibility - Glow LED

The IP 69 water proofed lights do not require maintenance and offer a traffic safe signal with both rear and forward lights.

More than just a ordinary reflector.

The big DIN 67520 reflector panels highlight the spreader effectively - even in full daylight.

Efficient protection

M-line spreaders are equipped with stainless safety guards protecting against the rotating parts. Fulfills EN 14017.



Marker light

The forward facing marker light marks the width of the spreader for oncoming traffic.



Safety guard

The M-line spreader is equipped with stainless safety guards - protecting against the rotating parts of the spreading system. Fulfills EN 14017



Easy access for cleaning

The hinged safety guards can be opened side ways to give unhindered access for cleaning the spreading device.



Deflectors for cleaning

Behind the reflector panels are unique access ports which deflect the cleaning water from a hose into areas which are normally not easy to reach.



SERVICING CLEANING AND MAINTENANCE

Considered in every detail - all the way

Thought has been given to the natural work flow when designing the chassis - with priority on cleaning, servicing and maintenance. The result ensures that any operation can be carried out quickly and easily.

Unhindered access

The spreader is fitted with hinged safety bars and guards which gives direct access to the spreading device.

Quick and Thorough Cleaning

Behind the hinged reflector panels you will find access ports to washing deflectors, easing the cleaning process. Further a number of flush-openings in the chassis makes it possible to clean even hidden areas. The mud flaps protecting the spreading device against stones and mud thrown from the rear wheels of the tractor, can easily be slid out of position or removed for thorough and efficient cleaning.

Universal tool

A stainless steel universal tool is placed behind the left reflector panel. This tool is used for fastening the spreading vanes, opening the sieves and to set the rotating flow outlet. All settings on the spreader requiring a tool can be carried out by this universal tool.



Universal tool - always near by

Always in the right place. The universal tool is placed in the reflector panel for opening of the sieves, fastening the spreading vanes and setting of the rotating flow outlet.



Opening the sieves

When cleaning the sieve lock is released by using the universal tool.

HYDRAULIC OR MECHANICAL DRIVEN TRANSMISSION

The transmission is a sealed unit filled with high quality grease to ensure protection of all internal components for a long working life. The grease has excellent non-wearing capacity and protects the gears against overload. At the same time the transmission is protected by a fully sealed, water resistant friction clutch based on double belville washers, protecting against damage from extreme loads, particularly at Pto start or stop. The PTO-shaft is fitted with an over-run clutch.

Hydraulic or PTO-driven

You can choose between two different systems running the spreading device. As standard, the spreader is delivered with a PTO-shaft including free wheeling clutch.

As an option, a hydraulic drive system to run the spreading device is available for saving fuel and saving cost. The hydraulic system is a reliable and efficient solution which works at lower tractor engine revolutions than the traditional PTO-system.

TRANSMISSION AND DRIVE SYSTEMS



The hydraulic drive system is a economical and fuel saving solution.



The differential design including four meshing gears, results in a robust and resistant system with a strength two times higher than a traditional transmission. The transmission is covered by a three year factory warranty.



The integrated waterproof and maintenance free overload clutch, protects against damage on the tractor, the PTO-shaft and the transmission in case of PTO-start at high tractor revs.



On speed independent spreaders, the PTO-revolutions are monitored directly on the display.

CAREFUL SURFACE TREATMENT FROM A - Z

In 1994 BOGBALLE introduced powder painting as this method was proven to be the best possible surface treatment for a fertiliser spreader. The powder paint is extremely wear and impact resistant, together with excellent corrosion resistant characteristics.

Preparing perfect paint work starts when receiving the steel.

The process is extensive and consist of the following steps:

- Quality control of the steel
- Shot blasting
- Grinding and deburring all surfaces and edges
- 45 minutes of cleaning
- Powder painting
- Hardening
- Quality control

The powder application is loading the powder particles at 10-12000 volts to ensure sufficient static adherence.

Quality control ensures that all painted parts fulfil our high standards.



No sharp edges

All laser cut parts pass through several processes of grinding and deburring. The better the grinding, the more surface for the paint to stick - the better durability and quality.



45 minutes of cleaning

Each part is carefully cleaned in a 7-step cleaning process. The absolutely clean surface is then the perfect starting point for maximum powder paint adherence.

SURFACE TREATMENT



Resists more than 1000 hours of corrosion test.
Our systematic corrosion test runs for 1008 hours and is carried out in an artificial atmosphere according to the standard DS/EN ISO 9227.



The final result
The BOGBALLE "Flexi-Coat" is 30 times stronger than a traditional wet paint.



More than 45000 spreading tests.

More than 45000 full-scale test have been carried out in the BOGBALLE test facilities. All our experience and knowledge gained is available via bogballe.com or through our App.



Do your own fertiliser analysis

The test equipment evaluates and compares the quality of the actual fertiliser relative to the specification from the supplier. The test result can then be compared with our online fertiliser analysis - to determine the recommended spreader settings.



MORE THAN 50 YEARS EXPERT KNOWLEDGE

We care about precision and back in 1964 built our first test hall. Today we have at our disposal highly sophisticated test facilities covering 1600 m².

We are the only world wide producer of fertiliser spreaders, who do both 2D and 3D spreading tests. The 2D test is primarily for spread charts and the 3D test is the basis for developing automatic headland control, section control in wedges and variable rate control.

More than 45000 full-scale test have been carried out in the BOGBALLE test facilities. All our experience and knowledge gained is available via bogballe.com or through our App.



Double up on technology

3D test - for analyzing the distribution spreading at headland, wedges and at variable rates / differential application. 2D test - identically matches practical in field spreading.

Control units Offer a world of opportunities

CALIBRATOR ZURF

Field work is efficient and precisely controlled by the CALIBRATOR ZURF. And combined with the weighing technique, the spreader is transformed into a 100% fully automatically controlled spreader. The precision and the quantity spread is spot on - irrespective of changes in forward speed and field conditions.

Operating is easy with a logical menu-structure. Before starting the field work, planned field data can be downloaded via a USB stick. After spreading the actual field work is transferred and documented.

The CALIBRATOR ZURF, which is standard on the M60W, M45W and M35W, fulfils all requirements for operating, monitoring and recording spreading operations. It is also

available for the M45 and M35.

CALIBRATOR ICON

CALIBRATOR ICON is a controller for M45 and M35 spreaders without weighing technique. The user interface is based on intuitive icons and controls all important functions to achieve a professional result. Connecting a PC by a cable, field data is transferred from the CALIBRATOR ICON.

ISOBUS Controller

An ISOBUS Controller is a possibility for all spreaders with weighing technique. This solution enables the spreader to be controlled by the tractor ISOBUS Terminal. Our ISOBUS Controller meets the ISO11783 standard and controls all the functions on "W" spreaders. An ISOBUS break away plug connects the spreader to the tractor ISOBUS network.

CONNECTIVITY



CALIBRATOR ZURF



CALIBRATOR ICON



ISOBUS Controller

Maybe - you already have a GPS?

Perhaps you already have a GPS solution on your farm?

We are continuously testing the possibilities for connecting various external serial GPS systems for our CALIBRATOR ZURF and CALIBRATOR ICON. Therefore, the possibility is open for using a system already existing on your farm.

It is possible to connect the CALIBRATOR ZURF to a number of standard GPS systems via the serial connection to obtain automatic control in wedges and automatic on/off at the headland. An interface is required between the two systems like for example AgLeader, Trimble, TeeJet and TopCon.

CONNECTIVITY



TeeJet Matrix connected to CALIBRATOR ZURF



Trimble CFX750 connected to CALIBRATOR ZURF



TopCon terminal connected to CALIBRATOR ZURF

CALIBRATOR FREE - the all-round GPS App

Integrated headland and section control

CALIBRATOR FREE is a brilliant and flexible App for GPS-controlled headland management. The App runs on a standard Android tablet as a "plug and play" unit. The hardware required consists of a GPS antenna and a wireless iZURF WiFi communication module, connected to the CALIBRATOR ZURF.

Application maps via GPS

The CALIBRATOR FREE App includes the possibility of Variable Rate Application, applying different rates of fertiliser according to the position in the field. The Variable Rate Application maps can be based on yield maps, sensor reading via drones, satellite photos or soil samples.

The application map is based on the widely recognised and accepted SHAPE file format as most field management software is able to handle these type of files.

Among the many advantages of using application maps in modern agriculture, is the ability to redistribute the mineral fertiliser to obtain the best possible yield by increasing

or decreasing the quantity based on soil and crop potential. This ensures a more homogeneous growth and a more even crop for harvesting.

With the CALIBRATOR FREE App it is also possible to communicate directly with a crop sensor measuring the plant's nutrient requirements. This method makes it possible to predict the actual need for nitrogen in real time and at the same time automatically adjust the spreader to apply the optimal quantity.

Full documentation

After spreading a field, the tablet sends an email containing a job report as a document defining field name, quantity, working width etc.

One flexible solution

The Calibrator FREE system will function on any tractor brand or model, offering total versatility.



CONNECTIVITY

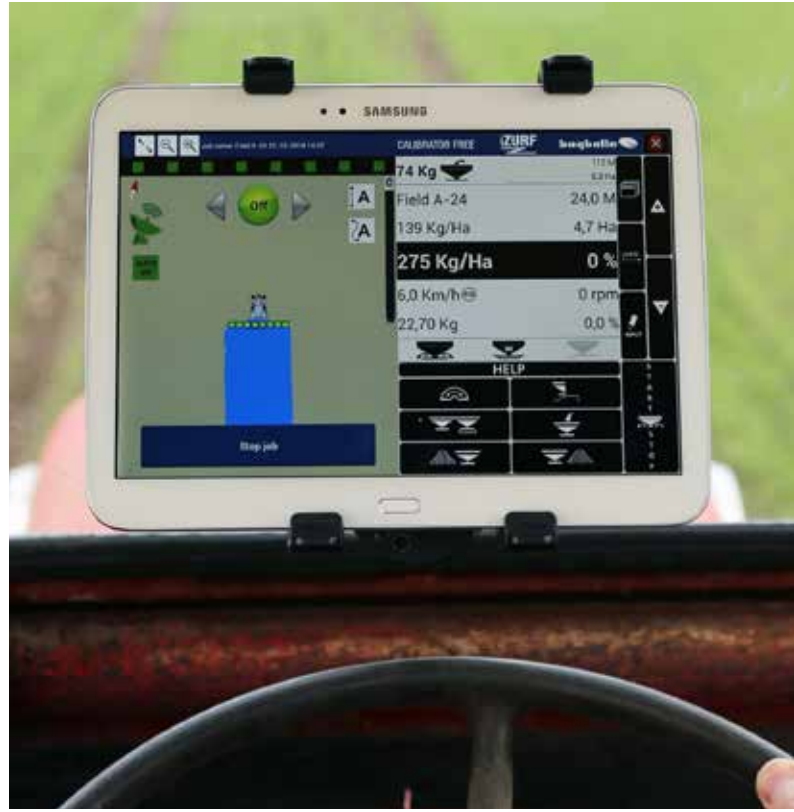

Use an Android tablet for fully automatic section control and variable rate application via GPS. It offers the possibility to upgrade even the farm's oldest tractor to the latest GPS technology.



Setting GPS guidance as straight or curved A - B lines.



The field report with full documentation is automatically generated as a PDF and a CVS file.



Make your own application maps - and import the files - easy and simple.

Ideal for fixed tramlines - no extra wheel marks in the headland crop

Turn in the headland tramline

Besides 100% overlapping and easy setting, the In-centre system has a crucial advantage. The system distributes the fertiliser from close to the spreader all the way across the spread pattern. Turning at the headland can therefore be completed in the headland tramline and not in the crop between the headland and the border. Significant crop damage is avoided by not having to turn in the crop.

TempoTracker

The exclusive BOGBALLE TempoTracker software is an integrated part of our Section Control; TempoTracker is designed to automatically control the closing and opening positions at the headland.

INTELLIGENT SPEED

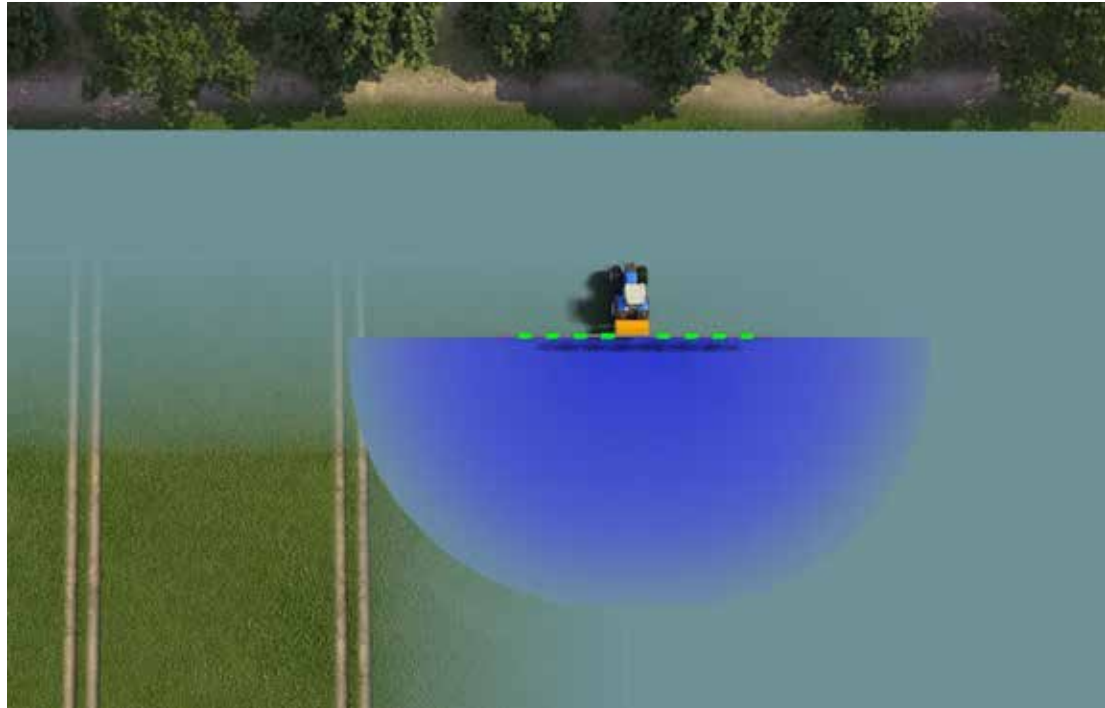

The In-centre system distributes the fertiliser all the way across the spreader. Turning at the headland is therefore in the headland tramlines and not in the crop between the headland and the border. Significant crop damage and loss is avoided not having to turn in the crop.

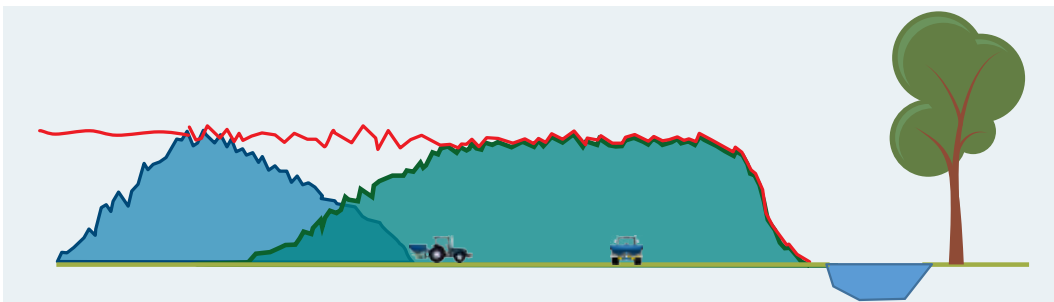

The TempoTracker software calculates the Start/Stop positions based on the forward speed, quantity and working width.

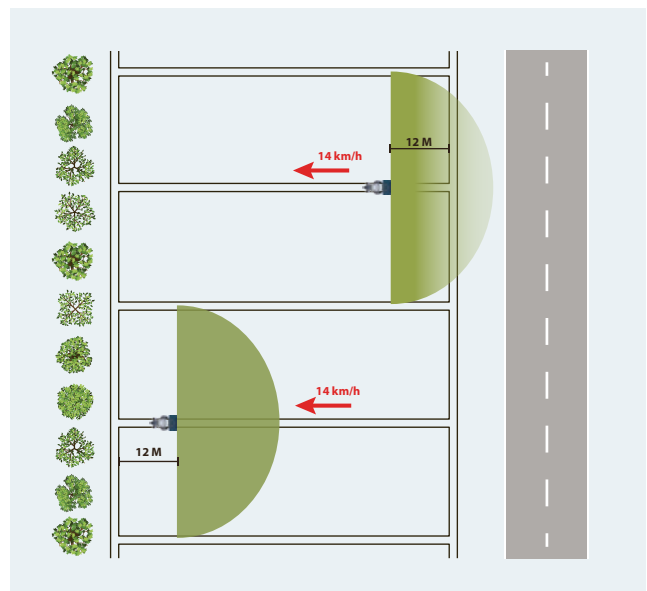
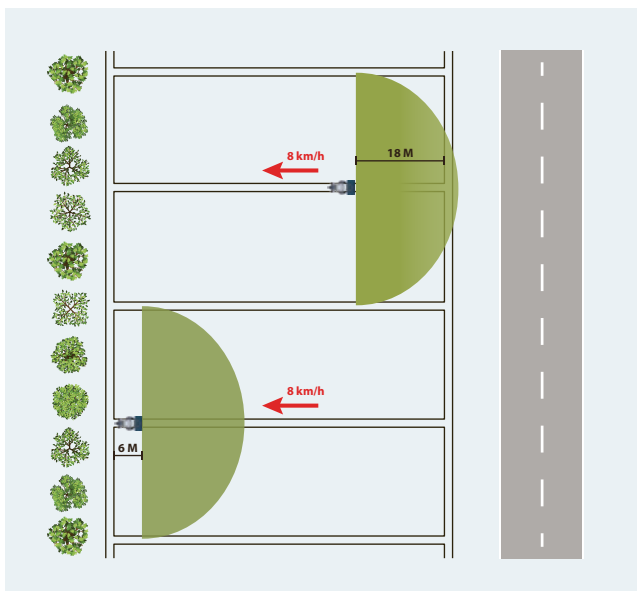

The forward speed toward the headland is typically lower than the forward speed driving into the field.

Dual Dynamic through our section control.

Dual Dynamic

Dual Dynamic combines the asymmetric spread pattern of "Dynamic Section Control" performed at headland wedges - with "Dynamic Differential Control", spreading variable rate / differential application to left or right.

Dynamic Section Control

Dynamic Section Control adjusts and controls the spread pattern according to the shape of the field, for example in angled headlands or wedges. The number of sections is in principle infinite, which is illustrated on the controller as main and sub sections. The control is accomplished in a way that the main sections are divided into unlimited and dynamic flow - opening and closing the "sections" gradually.

The system automatically opens and closes the the shutters of the spreader in areas where fertiliser is already been applied - like at the headland.

Asymmetric spread pattern

The Dynamic shutters create an asymmetric spread pattern by displacing the pattern and at the same time reducing the quantity in angled or wedged area. The gradual transition ensures optimal and even application in overlapping areas, minimising the risk of over or under application and ensuring the correct application quantity over the total field area.

WEDGE SPREADING

Dynamic control not activated



Dynamic control activated



All sections open

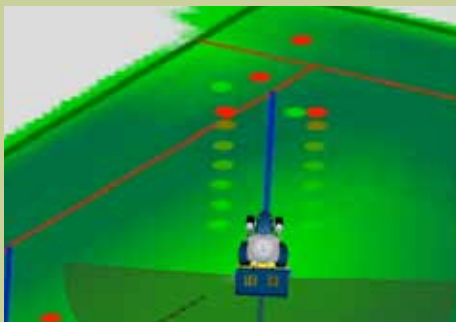
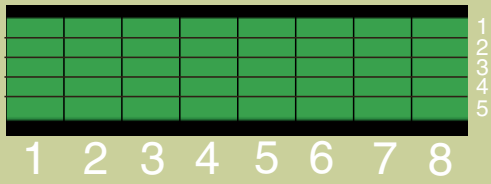

6 whole sections closed

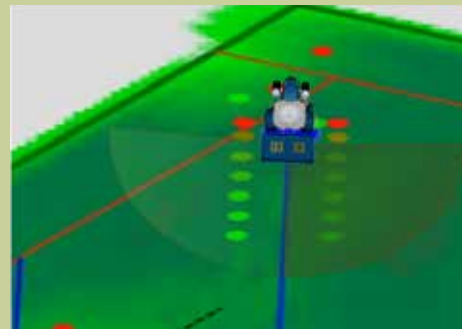
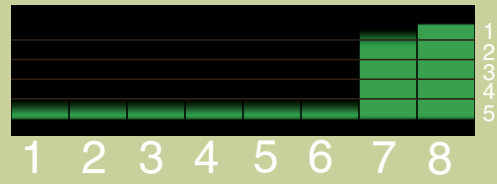

Symmetric spread pattern

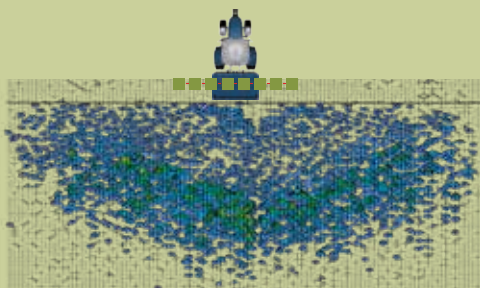
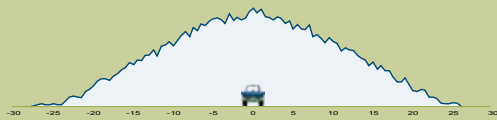

Asymmetric spread pattern 6 of 8

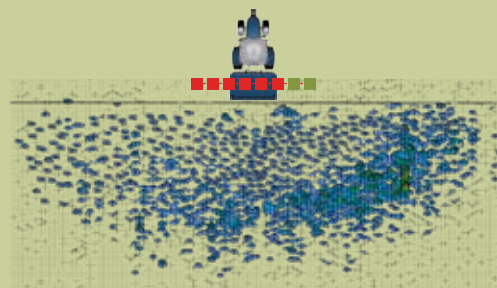
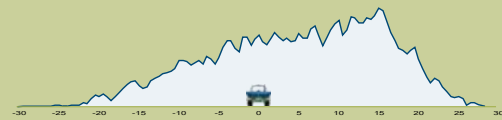

APPLICATION MAP - FIRST MOVERS

In 1991 BOGBALLE was the first spreader manufacturer offering GPS based variable rate application.

Today we offer Dynamic Differential Control controlling both the application quantity and the shape of the spread pattern.

The shutters of the spreader control and modify the application of fertiliser across the working width. The planned application, according to the application map, is then applied in gradual transitions.

Often software systems are seeing the field as small individual and sharply separated areas. But in reality, the shift from one rate area to another is more gradual with smooth changes. Our Dynamic Differential Control adapts the quantity and spread gradually to match the actual conditions in the field.

Our CALIBRATOR FREE is calculating the quantity across the working width and the distribution behind the spreader is automatically corrected. This secures an optimal application - also in the overlapping areas (see page 36).

Our CALIBRATOR and ISOBUS solutions makes it possible for a wide range of GPS-assisted controllers to carry out differential application (see page 34).

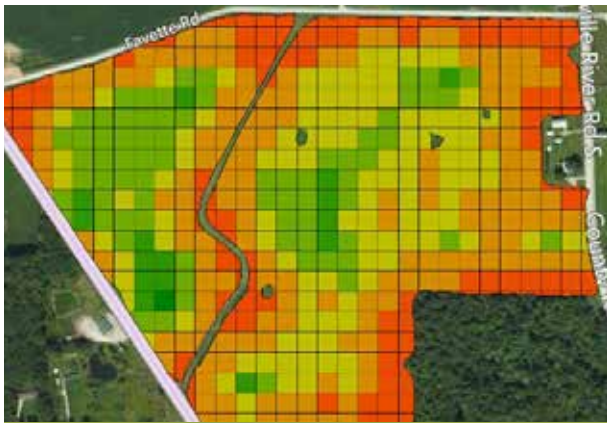
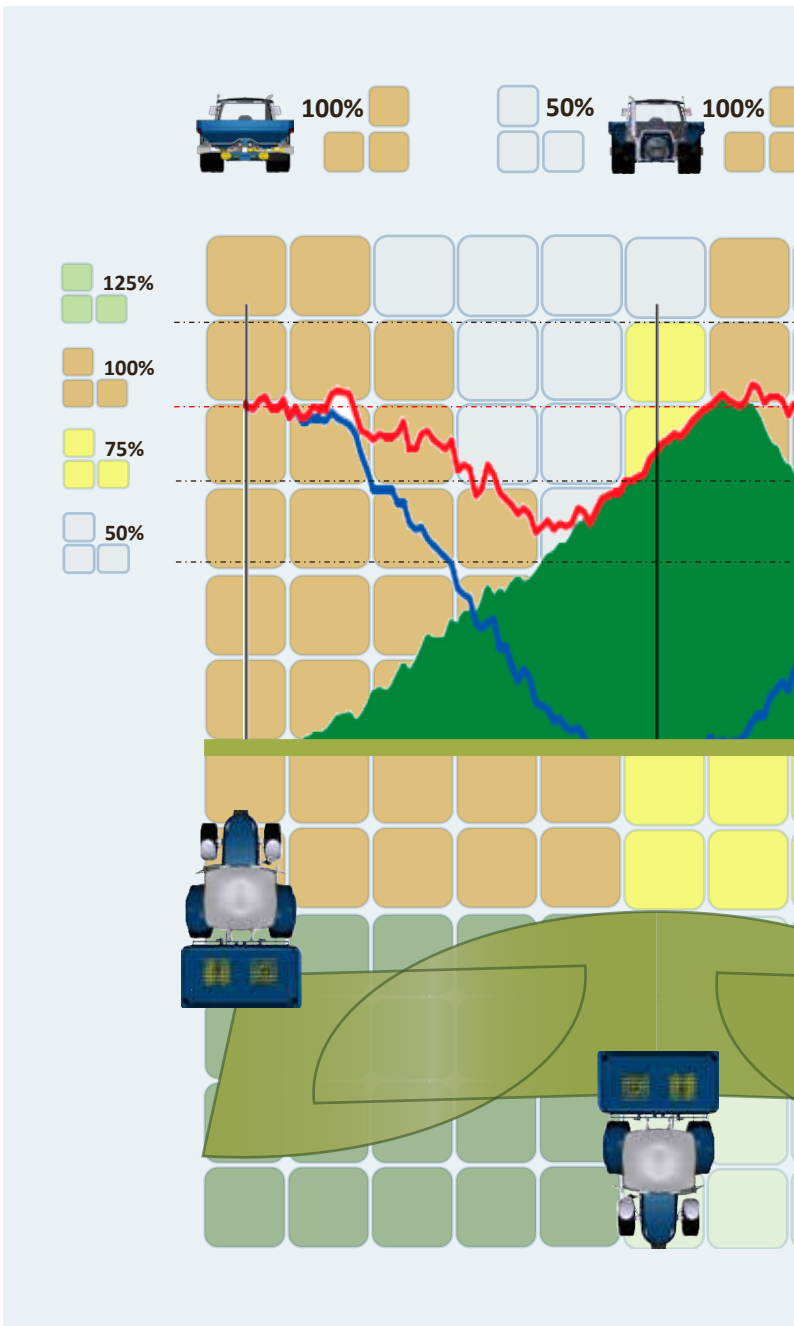

Application map

The CALIBRATOR FREE transforms the application map into graduated and smooth transitions.



Android tablet

Use a standard Android tablet for application maps using the CALIBRATOR FREE App.

APPLICATION MAP

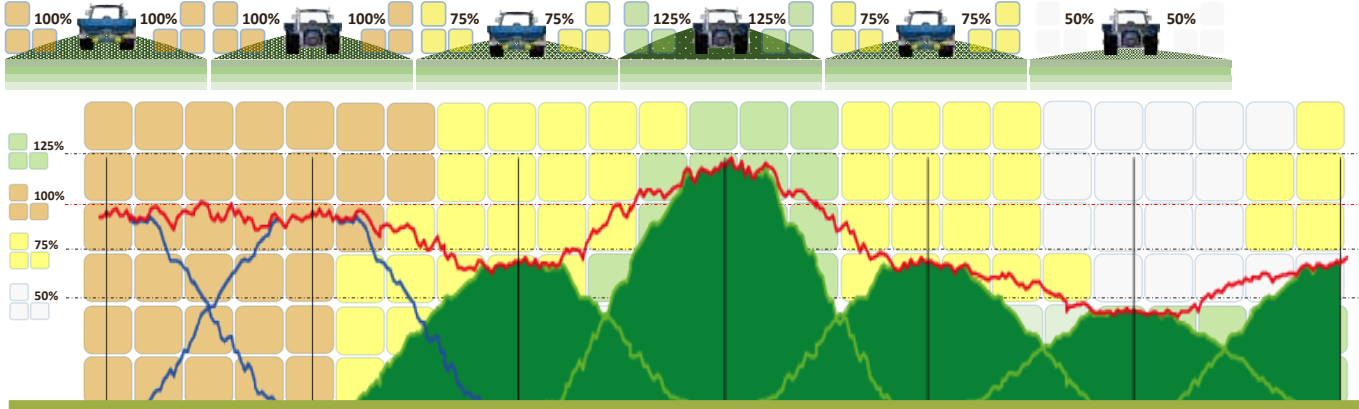
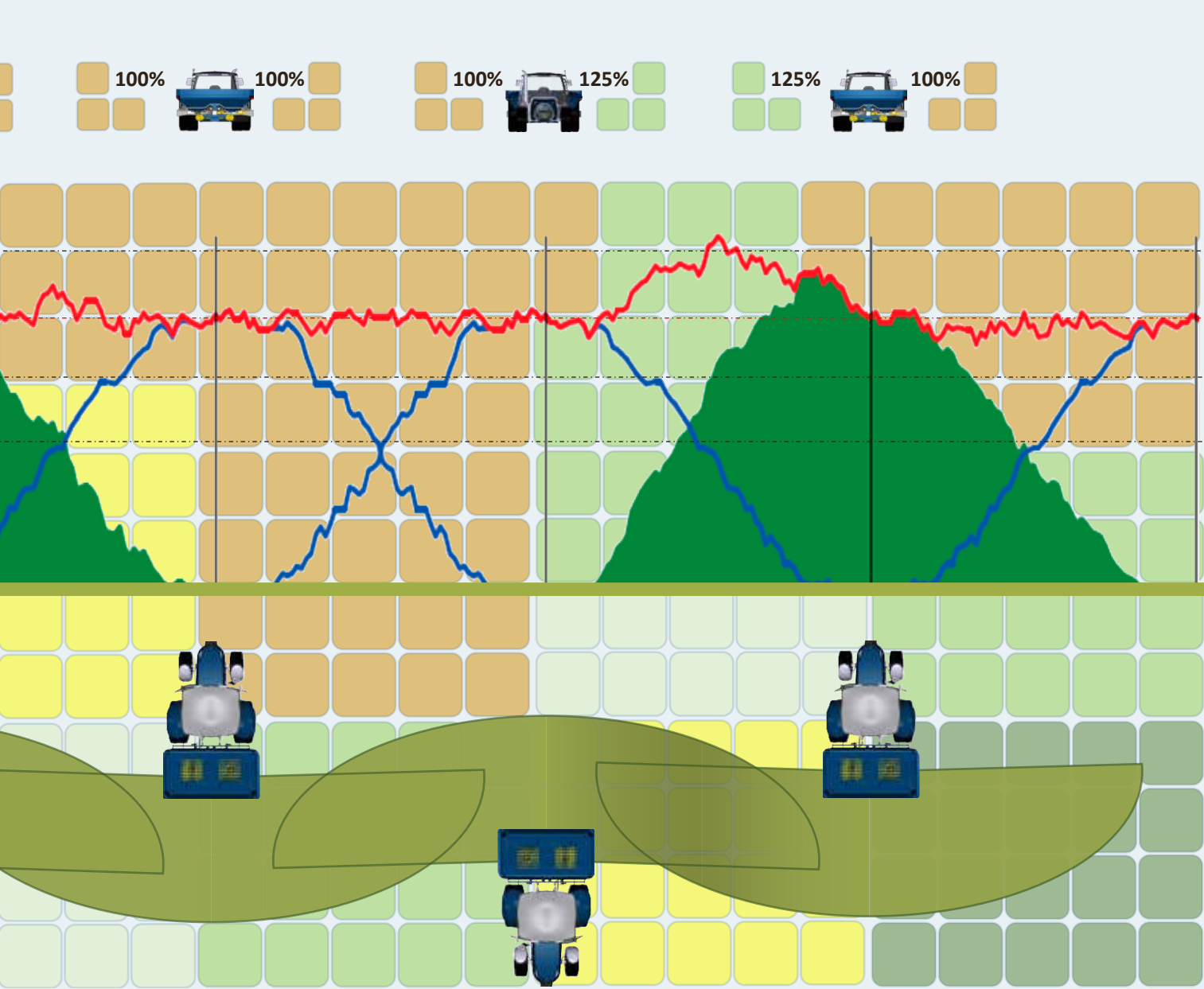

Flexibility at highest level
 Differential application from 150 Kg/ha to 450 Kg/ha at 28 meter.

WE CAN LIFT AND WE CAN CARRY.

M45-Trail and M35-Trail

If you have the need for a smaller tractor to "carry" a big spreader then you will find the perfect match in our program of trailed chassis. The adjustable wheel track width offers the possibility of suiting most tramline and row crop widths. The spreader can of course still be used as a 3-point linkage machine, for example for late top dressing. Our trailed chassis can be used together with all M-line spreaders - except the M60W model.

BXL1300

The Big Bag lifter BXL 1300 is mounted on the 3-point linkage of the spreader to provide a one man loading and spreading machine. Place the Big Bags in the field and get a capacity increase of 3-5 Ha / hour. The telescopic and hydraulic extension arm can lift the Big Bags directly from the ground or from a trailer. Maximum load capacity is 1300 Kg.

The main lift cylinder is fitted with an anti-drop valve to give safety and security during work. The BXL 1300 can be fitted on spreaders up to 3300 litres capacity.

WE WILL CARRY THE LOAD



BXL 1300 can lift up to 1300 Kg and can be fitted on spreaders up to 3300 litres.



M35-Trail for spreaders up to 3500 Kg.



M45-Trail for spreaders up to 4500 Kg.



The spreader can be dismantled and used for late top dressing in high crops.

	M60W plus	M45W plus	M35W plus	M35W base	M45 plus	M35 plus	M35 base
Equipment							
Headland spreading to border (Manual)	—	—	—	—	●	●	●
Headland spreading from border (Manual)	—	—	—	—	○	○	○
Headland spreading to/from border (Manual)	—	—	—	—	○	○	○
Remote cable control for headland spreading	—	—	—	—	○	○	○
Headland spreading to border (Electrical)	●	●	●	●	○	○	○
Headland spreading from border (Electrical)	○	○	○	○	○	○	○
Headland spreading to/from border (Electrical)	○	○	○	○	○	○	○
PTO c/w overrun clutch	●	●	●	●	●	●	●
Waterproof overload clutch	●	●	●	●	●	●	●
Sieves included cone	●	●	●	●	●	●	●
Top dressing console	●	●	●	●	●	●	●
Tilt indicator for adjustment of the spreader	●	●	●	●	●	●	●
Mud flaps	●	●	●	●	●	●	●
Rotating flow outlet with 4 outlets (0-650 Kg/min)	●	●	●	●	●	●	●
Dynamic Section Control	○	○	○	○	○	○	○
Standard Section Control	○	○	○	○	○	○	○
iZURF communication module	○	○	○	○	—	—	—
GPS antenna for iZURF	○	○	○	○	—	—	—
Reflector panel included GLOW LED traffic light	●	●	●	●	●	●	●
Safety bar, fulfills EN 14017	●	●	●	●	●	●	●
Hopper cover, folding and full width opening	○	○	○	○	○	○	○
Transport wheels for manual moving	○	○	○	○	○	○	○
Ladder, folding	●	●	○	○	●	○	○
Ladder, side fitted	○	○	○	○	○	○	○
Sieves, top mounted full size	○	○	○	—	○	○	—
Extra wide guards for wide tyres	●	●	○	○	●	○	○
Reduction gear, 1000/540 and 540/540 rev. included transport wheels.	—	○	○	○	○	○	○
Hydraulic drive system for the spreading device.	○	○	○	○	○	○	○
Flow control, controlling oil flow / revolutions	○	○	○	○	○	○	○
Outer linkage Ø37 mm	—	○	—	—	○	—	—
Adapter for Cat. 4N lift	○	—	—	—	—	—	—
Agitator for grass seeds	○	○	○	○	○	○	○
S-indicator for setting the quantity	○	○	○	○	●	●	●
Test set for fertiliser analysis, bag including D-indicator and F-indicator	●	●	●	●	○	○	○
Speed input plug ISO 11786	○	○	○	○	○	○	○
Wheel sensor inductive for CALIBRATOR	○	○	○	○	○	○	○
Pilot check valve, prevents oil from leaving the hydraulic remote control cylinder	—	—	—	—	○	○	○

- Standard
- Extra
- Not available

EQUIPMENT AND ACCESSORIES



M60W plus

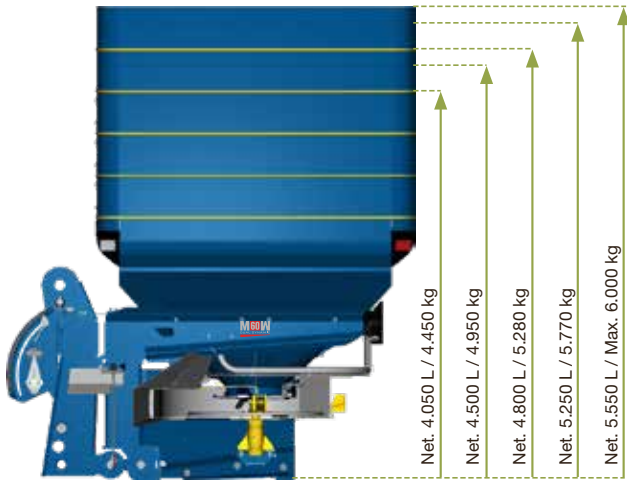

M45W plus

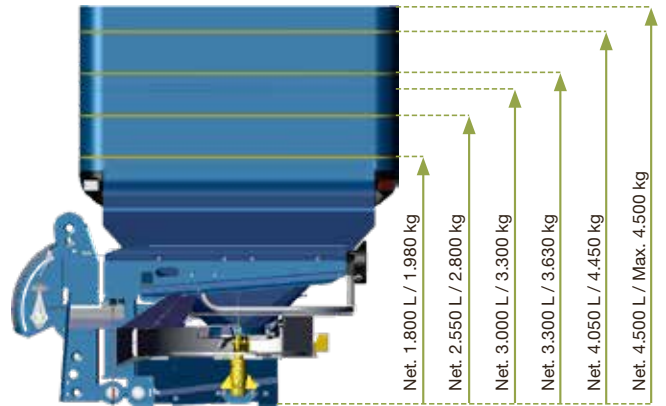

M35W / M35 plus

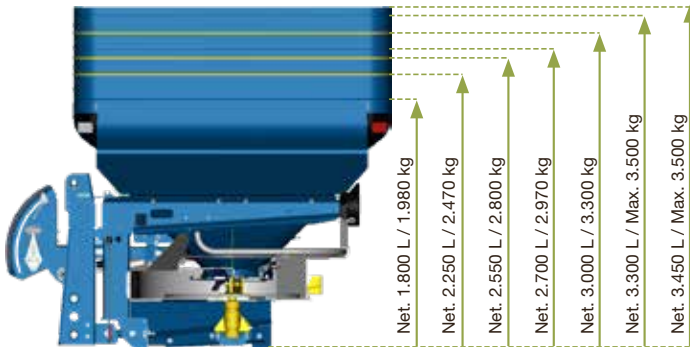

M35W / M35 base

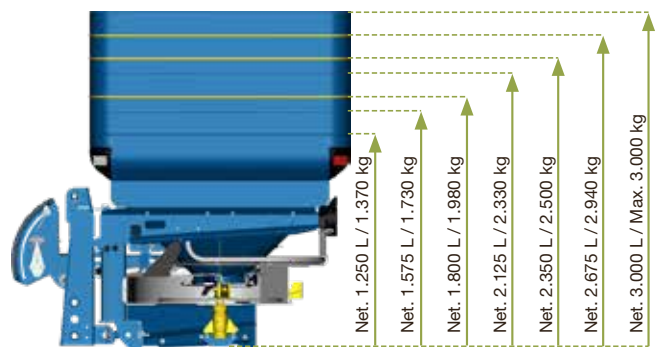

M45-Trail

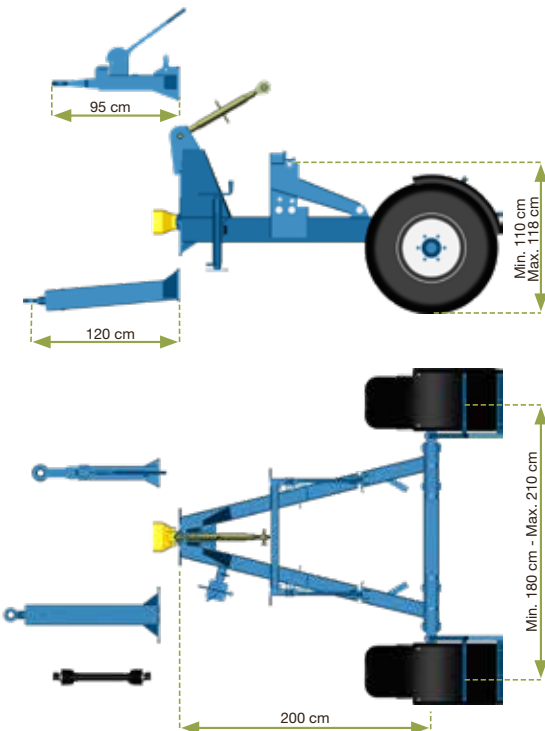

M35-Trail

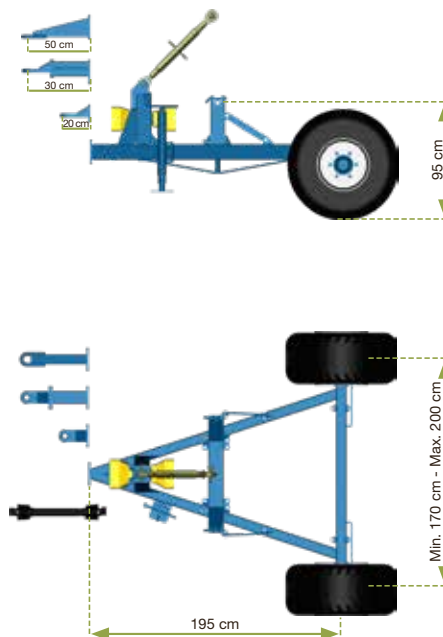

BXL 1300

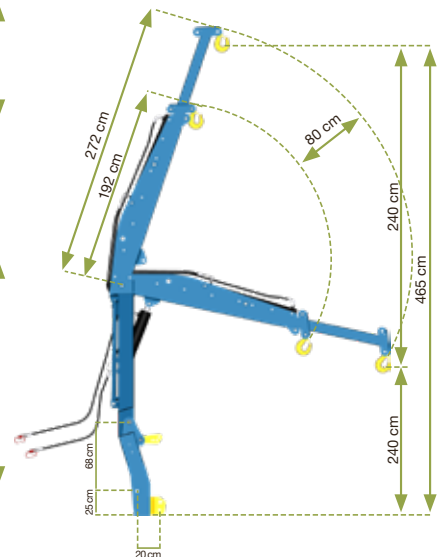

	M60W plus	M45W plus	M35W plus	M35W base	M45 plus	M35 plus	M35 base
Working width ^A							
Metres	12-42	12-42	12-42	12-42	12-24	12-42	12-42
Capacity							
Litres	4.050-5.550	1.800-4.500	1.800-3.500	1.250-3.000	1.800-4.500	1.800-3.500	1.250-3.000
Kilo ^B	4.450-6.000	1.980-4.500	1.980-3.500	1.370-3.000	1.980-4.500	1.980-3.500	1.370-3.000
Net weight							
Kilo (min. / max.)	966/1.044	660/816	534/636	490/602	510/666	450/552	406/518
Hopper dimensions							
Hopper width (cm)	290	290	290	240	290	290	240
Hopper depth (cm)	140	140	140	125	140	140	125
Fill opening (cm)	284 x 131	284 x 131	284 x 131	234 x 116	284 x 131	284 x 131	234 x 116
Distance from centre of lower link balls to centre of gravity							
Metres	0,85	0,71	0,70	0,70	0,67	0,66	0,66
Control unit							
CALIBRATOR ZURF	●	●	●	●	○	○	○
CALIBRATOR ICON	—	—	—	—	○	○	○
ISOBUS Controller	●	●	●	●	—	—	—
iZURF WIFI module ^C	○	○	○	○	○	○	○
Hydraulic	—	—	—	—	○	○	○
Control of spread pattern							
Section Control Dual Dynamic +VRA	○	○	○	○	○	○	○
Section Control Standard +VRA	○	○	○	○	○	○	○
External GPS Ready ^D	○	○	○	○	○	○	○
Quantity control							
Weighing system	●	●	●	●	—	—	—
Manual calibration	—	—	—	—	●	●	●
Fully automatic calibration	●	●	●	●	—	—	—
Intelligent control	●	●	●	●	—	—	—
Speed relation	●	●	●	●	○	○	○

- Standard
- Depending on model
- Extra
- Not available

^A Can depend on fertiliser type

^B Density 1,1 kg pr. litre. Axle load on public roads must comply with national restrictions

^C Can only be used for spreaders with CALIBRATOR ZURF

^D Can only be used for spreaders with CALIBRATOR or ISOBUS Controller

FIND YOUR LOCAL DEALER ON
www.bogballe.com



FIND US ALL OVER THE WORLD

You can find BOGBALLE spreaders in more than 100 countries worldwide and every single country will have different standards as to how a spreader must perform. Still, common for all countries is that they expect an accurate application of fertiliser. That is the reason for our wide product range that exactly fulfils this requirement, no matter if it is a simple manual controlled spreader or the most sophisticated spreader with fully automated solutions and GPS control.

We sell our spreaders through locally based dealers and each has in depth knowledge of the local conditions. This combined with the fact that the spreader consists of standard components that feature throughout the complete product programme, ensures that your spreader always remains in top form. It also ensures a ready supply of wear and spare parts in your local area.

To choose BOGBALLE is a safe choice all the way, not only for the confidence in the precise handling of the valuable fertiliser you spread in the field, but also when it comes to the total costs through the complete lifespan of the spreader.



boqballe 
it works

FIND MORE INFORMATION ON
www.bogballe.com

Importer:

Dealer: